

DRAWING FOR CUSTOMER

NOTES:

- HUOSINGT:LCP HIGH-TEMP THERMOPLASTIC UL94V-0 COLOR:BEIGE
- ACTUATOR:LCP HIGH-TEMP THERMOPLASTIC UL94V-0 COLOR:BLACK
- TERMINAL: PHOSPHOR BRONZE
PLATING:GOLD FLASH OR MATTE-TIN OR TIN (LEAD FREE)
- FITTING NAIL: BRASS
PLATING:MATTE-TIN OR TIN (LEAD FREE)

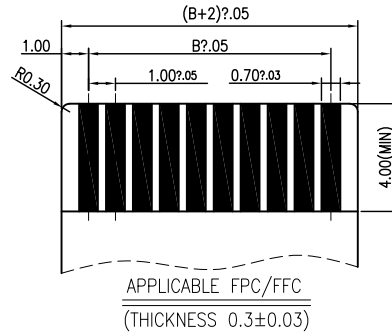
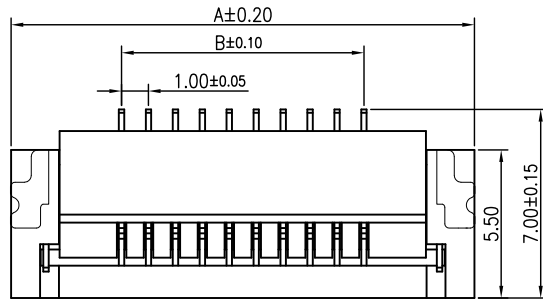

KBF1007-XX X S R 260 L 2 A

Pin No.

包裝方式:

T:TUBE (管裝)

R:REEL (卷裝)

P: PE (袋裝)

S:SMT

R:Right Angle

V:Vertical

Version

Mold No.

Contacts Type:U:Upper

L:Lower

R:Right

F:Left

D:Double

H厚度: 1.0mm=100

1.2mm=120

1.5mm=150

2.0mm=200

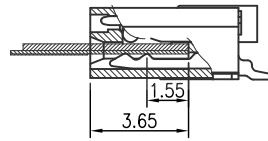
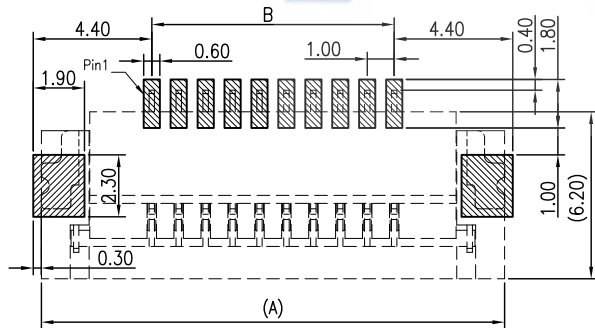
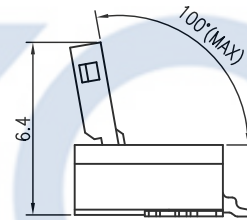
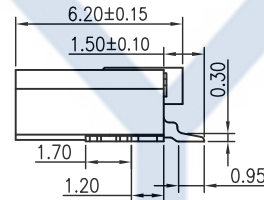
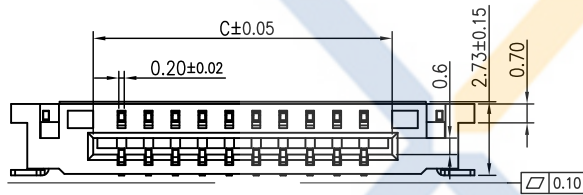

CABLE INSERT DIM.

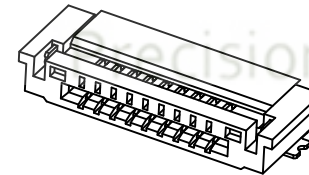

No. of contacts	Dimensions			No. of contacts	Dimensions		
	A	B	C		A	B	C
4	11.2	3.0	5.1	18	25.2	17.0	19.1
5	12.2	4.0	6.1	19	26.2	18.0	20.1
6	13.2	5.0	7.1	20	27.2	19.0	21.1
7	14.2	6.0	8.1	21	28.2	20.0	22.1
8	15.2	7.0	9.1	22	29.2	21.0	23.1
9	16.2	8.0	10.1	23	30.2	22.0	24.1
10	17.2	9.0	11.1	24	31.2	23.0	25.1
11	18.2	10.0	12.1	25	32.2	24.0	26.1
12	19.2	11.0	13.1	26	33.2	25.0	27.1
13	20.2	12.0	14.1	27	34.2	26.0	28.1
14	21.2	13.0	15.1	28	35.2	27.0	29.1
15	22.2	14.0	16.1	29	36.2	28.0	30.1
16	23.2	15.0	17.1	30	37.2	29.0	31.1
17	24.2	16.0	18.1	31	38.2	30.0	32.1

RECOMMENDED PCB PATTERN DIM.

TOLERANCE : ±0.05

XYCO 东莞市轩业电子科技有限公司
TEL: 0769-8297 9981/2/3 <http://www.XYCO.com.cn>

				TOLERANCE 公差		DRAWING 設計者 Devin		KBF1007-XXXSR260L2A			
2015-07-10	A	CHANGE HISTORY 變更歷史	KBF1007-XXXSR260L2A	Devin	.X=±0.30	CHECKED 審查	Thomas	PART NO. 料號			
DATE 日期	VER 版本				.XX=±0.20	APPROVED 核准	William	DWG NO. 圖號	PE1904026A	UNIT 單位	mm
					.XXX=±0.10					PRODUCT NAME 產品名稱	1.0 ZIF FPC SMT R/A B/C