

# DRAWING FOR CUSTOMER

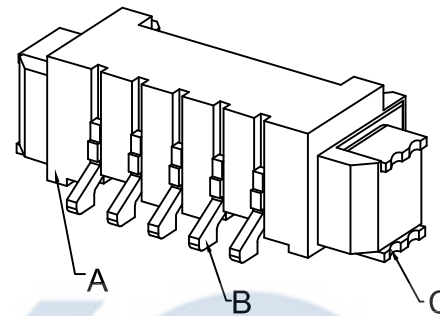
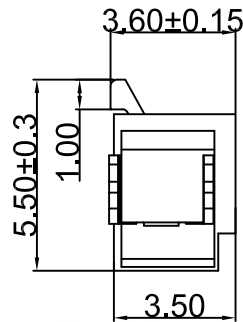
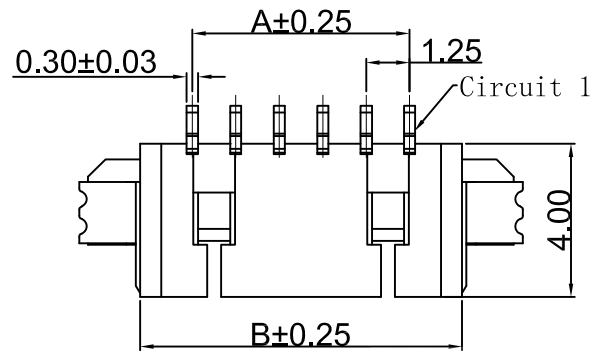

- SPEC.:
- Rated Voltage:125V AC,DC
  - Rated Current:1A AC,DC
  - Withstand Voltage:500V AC/minute
  - Contact Resistance:20mΩ max
  - Insulation Resistance:100MΩ min
  - Temperature Range:-25℃~+105℃

- Material
- Insulator(A):LCP UL94V-0
  - Contact(B):Phosphor Bronze  
Finish:Gold/Tin-Plated;over Nickel
  - Solder Tab(C):Brass  
Finish:Tin-Plated,over Nickel

KB915-XX X S R 6 A

Pin No.

Version

T:TUBE (管装)  
R:REEL (卷装)  
P:PE (袋装)

Mold No.

D:DIP  
S: SMT

R:Right Angle  
V:Vertical

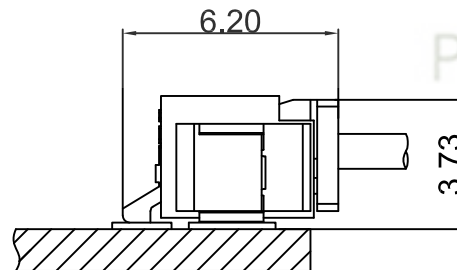
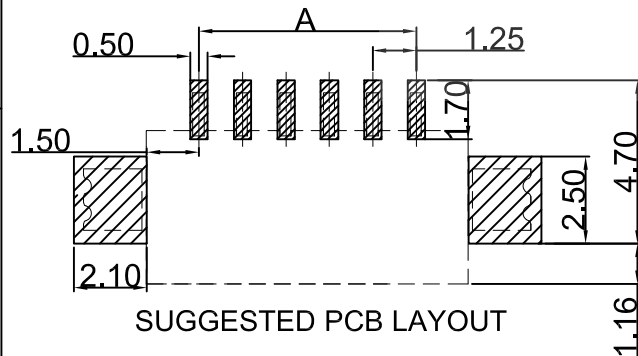
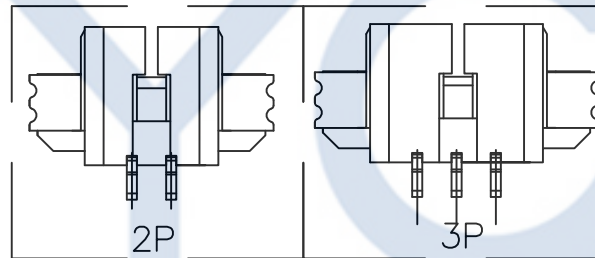
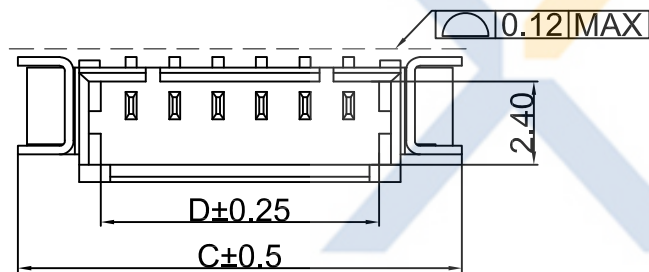

Poles	Dimensions (mm)			
	A	B	C	D
02	1.25	4.25	7.75	3.20
03	2.50	5.50	9.00	4.45
04	3.75	6.75	10.25	5.70
05	5.00	8.00	11.50	6.95
06	6.25	9.25	12.75	8.20
07	7.50	10.50	14.00	9.45
08	8.75	11.75	15.25	10.70
09	10.00	13.00	16.50	11.95
10	11.25	14.25	17.75	13.20
11	12.50	15.50	19.00	14.45
12	13.75	16.75	20.25	15.70
13	15.00	18.00	21.50	16.95
14	16.25	19.25	22.75	18.20
15	17.50	20.50	24.00	19.45
16	18.75	21.75	25.25	20.70

**XYCO** 东莞市轩业电子科技有限公司  
TEL: 0769-8297 9981/2/3 http://www.XYCO.com.cn

2013-09-20		A			KB915-XXXSR6A	Devin	XYCO		UNIT		53261 PH1.25mm Wire To Board	
DATE	VER	CHANGE HISTORY	CHANGED NAME	DRAWING	TOLERANCE	DRAWING	DEVIN	PART NO.	料號	mm	PRODUCT NAME	53261 PH1.25mm Wire To Board
日期	版本	變更歷史	修改後料號	變更者	.X=±0.30 .XX=±0.20 .XXX=±0.10	設計者	Devin	DWG NO.	圖號		產品名稱	SMT Right Angle Wafer
1	2	3	4	5	6	7	8	9	10	11	12	13